

LM9044

Lambda Sensor Interface Amplifier

General Description

The LM9044 is a precision differential amplifier specifically designed for operation in the automotive environment. Gain accuracy is guaranteed over the entire automotive temperature range (-40°C to $+125^{\circ}\text{C}$) and is factory trimmed after package assembly. The input circuitry has been specifically designed to reject common-mode signals as much as 3V below ground on a single positive power supply. This facilitates the use of sensors which are grounded at the engine block while the LM9044 itself is grounded at chassis potential. An external capacitor sets the maximum operating frequency of the amplifier, thereby filtering high frequency transients. Both inputs are protected against accidental shorting to the battery and against load dump transients. The input impedance is typically 1 M Ω .

The output op amp is capable of driving capacitive loads and is fully protected. Also, internal circuitry has been provided to

detect open circuit conditions on either or both inputs and force the output to a "home" position (a ratio of the external reference voltage).

Features

- Normal circuit operation guaranteed with inputs up to 3V below ground on a single supply.
- Gain factory trimmed and guaranteed over temperature ($\pm 3\%$ of full-scale from -40°C to $+125^{\circ}\text{C}$)
- Low power consumption (typically 1 mA)
- Fully protected inputs
- Input open circuit detection
- Operation guaranteed over the entire automotive temperature range (-40°C to $+125^{\circ}\text{C}$)
- Single supply operation

Schematic and Connection Diagrams

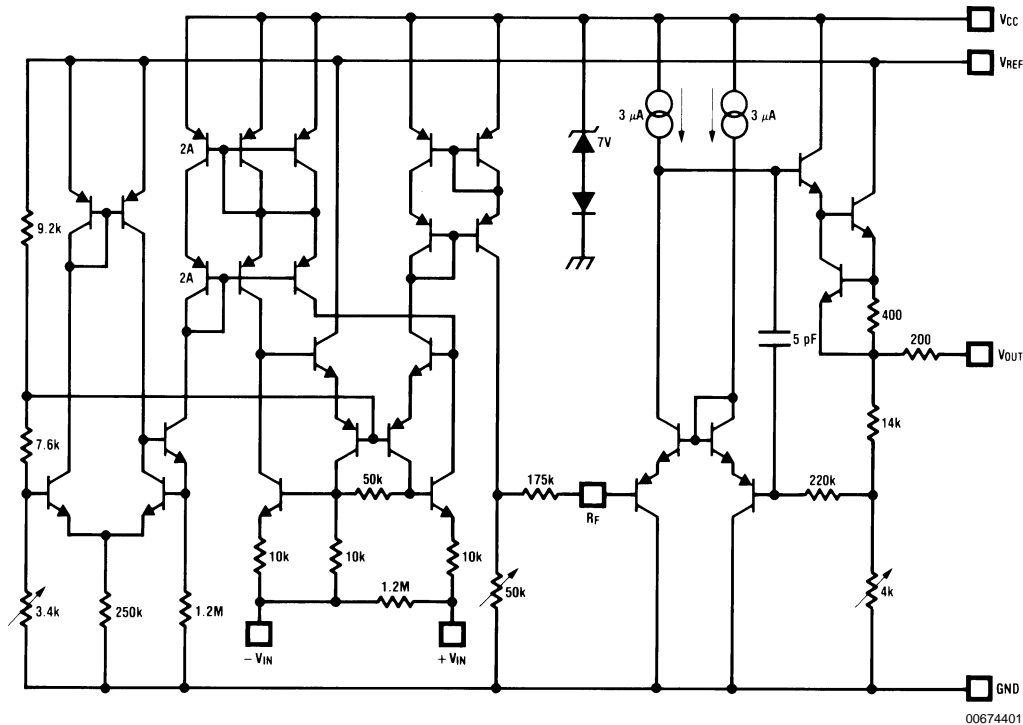

Schematic and Connection Diagrams (Continued)

Plastic Chip Carrier Package

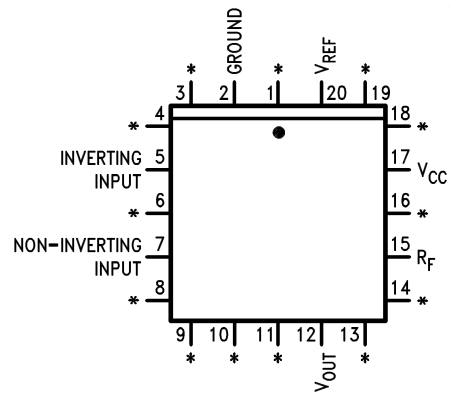

00674406

Top View
Order Number LM9044V
See NS Package Number V20A

*Pins 1, 3, 4, 6, 8, 9, 10, 11, 13, 14, 16, 18, 19 are trim pins and should be left floating.

Absolute Maximum Ratings (Note 1)

If Military/Aerospace specified devices are required, please contact the National Semiconductor Sales Office/Distributors for availability and specifications.

V_{CC} Supply Voltage ($R_{V_{CC}} = 15\text{ k}\Omega$)	$\pm 60\text{V}$
V_{REF} Supply Voltage	-0.3V to $+6\text{V}$
DC Input Voltage (Either input)	-3V to $+6\text{V}$
Input Transients (Note 2)	$\pm 60\text{V}$
Power Dissipation see (Note 7)	1350 mW
Output Short Circuit Duration	Indefinite

Operating Temperature Range	-40°C to $+125^{\circ}\text{C}$
Storage Temperature Range	-65°C to $+150^{\circ}\text{C}$
Soldering Information	
Plastic Chip Carrier Package	
Vapor Phase (60 seconds)	215°C
Infrared (15 seconds)	220°C
See AN-450 "Surface Mounting Methods and Their Effect on Product Reliability" for other methods of soldering surface devices.	

Electrical Characteristics $V_{CC} = 12\text{V}$, $V_{REF} = 5\text{V}$, $-40^{\circ}\text{C} \leq T_A \leq 125^{\circ}\text{C}$ unless otherwise noted

Parameter	Conditions	(Note 3)			(Note 4)			Units
		Min	Typ	Max	Min	Typ	Max	
Differential Voltage Gain	$V_{DIF} = 0.5$, $-1\text{V} \leq V_{CM} \leq +1\text{V}$	4.41	4.50	4.59				V/V
	$V_{DIF} = 0.5$, $-3\text{V} \leq V_{CM} \leq +1\text{V}$				4.36	4.50	4.64	V/V
Gain Error (Note 6)	$0 \leq V_{DIF} \leq 1\text{V}$, $-1\text{V} \leq V_{CM} \leq +1\text{V}$	-2	0	2				%/FS
	$0 \leq V_{DIF} \leq 1\text{V}$, $-3 \leq V_{CM} \leq +1\text{V}$				-3	0	3	%/FS
Differential Input Resistance	$0 \leq V_{DIF} \leq 1\text{V}$, $-1\text{V} \leq V_{CM} \leq +1\text{V}$	0.95	1.20	3.00				$\text{M}\Omega$
	$0 \leq V_{DIF} \leq 1\text{V}$, $-3 \leq V_{CM} \leq +1\text{V}$				0.70	1.20	4.00	$\text{M}\Omega$
Non-Inverting Input Bias Current	$0 \leq V_{DIF} \leq 1\text{V}$, $-1 \leq V_{CM} \leq +1\text{V}$		± 0.38	± 0.65				μA
	$0 \leq V_{DIF} \leq 1\text{V}$, $-3 \leq V_{CM} \leq +1\text{V}$					± 0.38	± 1.5	μA
Inverting Input Bias Current	$0 \leq V_{DIF} \leq 1\text{V}$, $-1 \leq V_{CM} \leq +1\text{V}$	-25	-65	-100				μA
	$0 \leq V_{DIF} \leq 1\text{V}$, $-3 \leq V_{CM} \leq +1\text{V}$					-45	-150	μA
V_{CC} Supply Current	$V_{CC} = 12\text{V}$, $R_{V_{CC}} = 15\text{k}$		300	500				μA
V_{RED} Supply Current	$4.75\text{V} \leq V_{REF} \leq 5.5\text{V}$		0.5	1.0				mA
Common-Mode Voltage Range (Note 5)		-1		1	-3		1	V
DC Common-Mode Rejection Ratio	Input Referred $-1\text{V} \leq V_{CM} \leq +1\text{V}$ $V_{DIF} = 0.5\text{V}$	50	60					dB
Open Circuit Output Voltage	One or Both Inputs Open, $-1\text{V} \leq V_{CM} \leq +1\text{V}$	0.371	0.397	0.423				XV_{REF}
	$-3\text{V} \leq V_{CM} \leq +1\text{V}$				0.365	0.397	0.439	XV_{REF}
Short Circuit Output Current	Output Grounded	1.0	2.7	5.0				mA
V_{CC} Power Supply Rejection Ratio	$V_{CC} = 12\text{V}$, $R_{V_{CC}} = 15\text{k}$ $V_{DIF} = 0.5\text{V}$	50	65					dB
V_{REF} Power Supply Rejection Ratio	$V_{REF} = 5\text{V}_{DC}$ $V_{DIF} = 0.5\text{V}$	60	74					dB

Note 1: Absolute Maximum Ratings indicate limits beyond which damage to the device may occur.

Note 2: This test is performed with a 1000Ω source impedance.

Note 3: These parameters are guaranteed and 100% production tested.

Note 4: These parameters will be guaranteed but not 100% production tested.

Note 5: The LM9044 has been designed to common-mode to -3V , but production testing is only performed at $\pm 1\text{V}$.

Note 6: Gain error is given as a percent of full-scale. Full-scale is defined as 1V at the input and 4.5V at the output.

Note 7: For operation in ambient temperatures above 25°C the device must be derated based on a maximum junction temperature of 150°C and a thermal resistance of 93°C/W junction to ambient.

Typical Performance Characteristics

Non-Inverting Input Bias Current vs Temperature

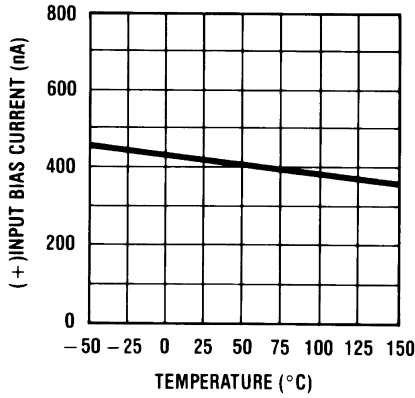

00674402

Inverting Input Bias Current vs Temperature

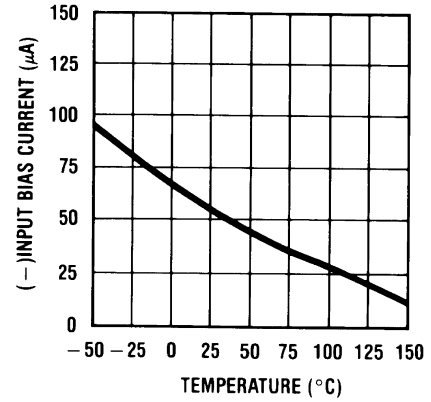

00674407

V_{REF} Supply Current vs Temperature

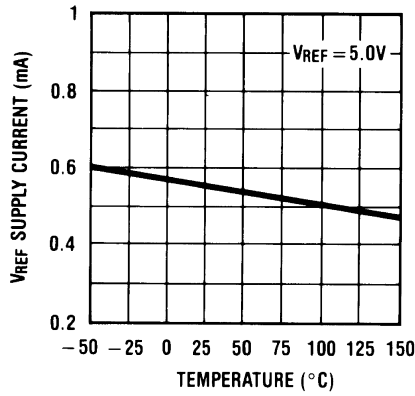

00674408

V_{CC} Supply Current vs Temperature

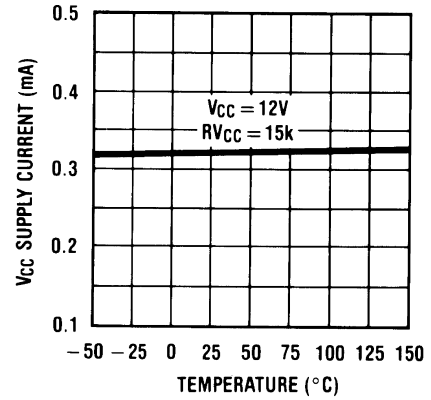

00674409

Short Circuit Output Current vs Temperature

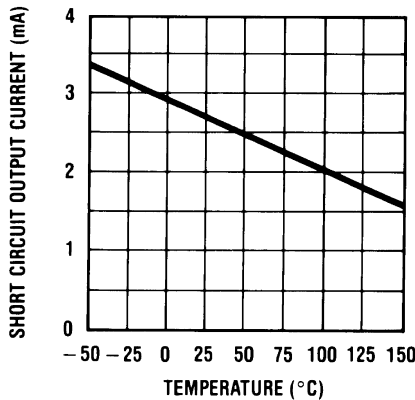

00674410

Differential Gain vs Temperature

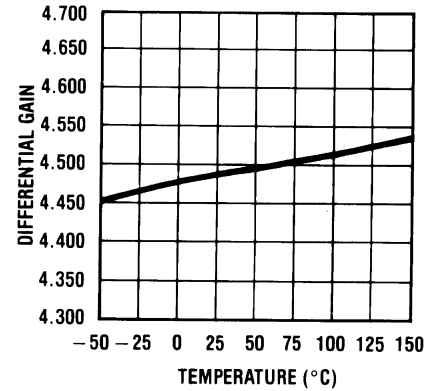

00674403

Typical Performance Characteristics (Continued)

Voltage Gain vs Frequency

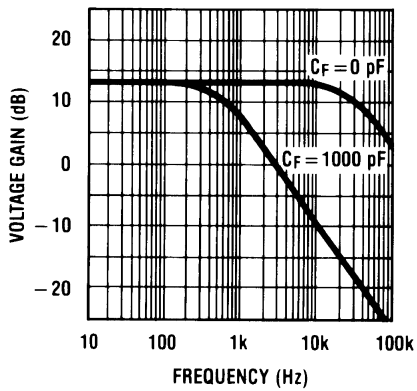

00674411

CMRR vs Frequency

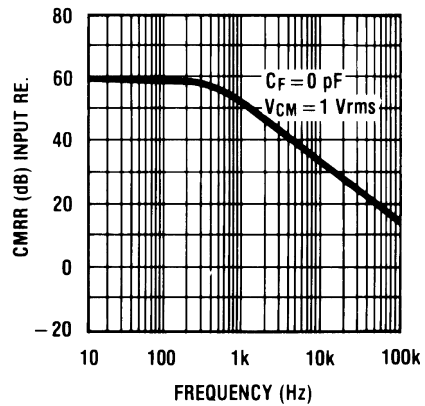

00674412

V_{REF} Power Supply Rejection

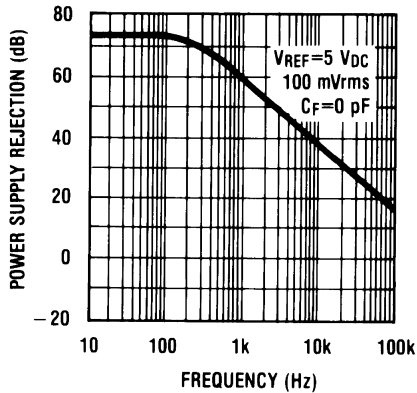

00674413

V_{CC} Power Supply Rejection

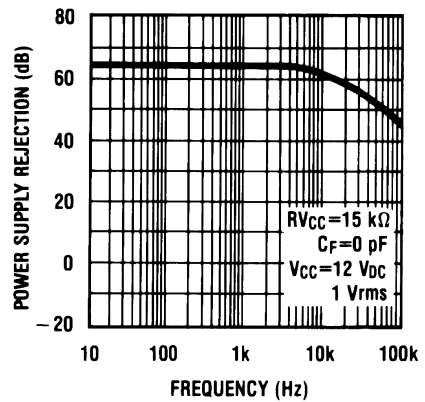

00674404

Test Circuit

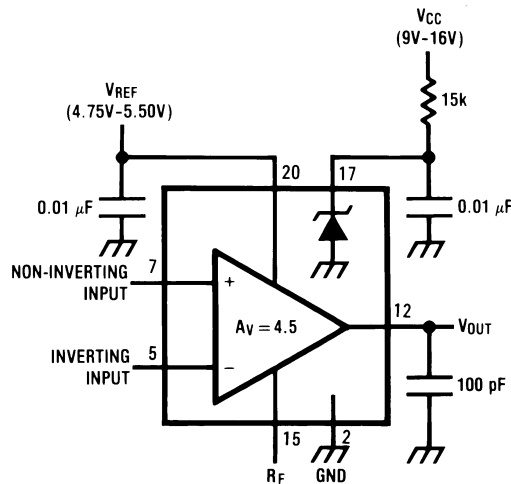

00674405

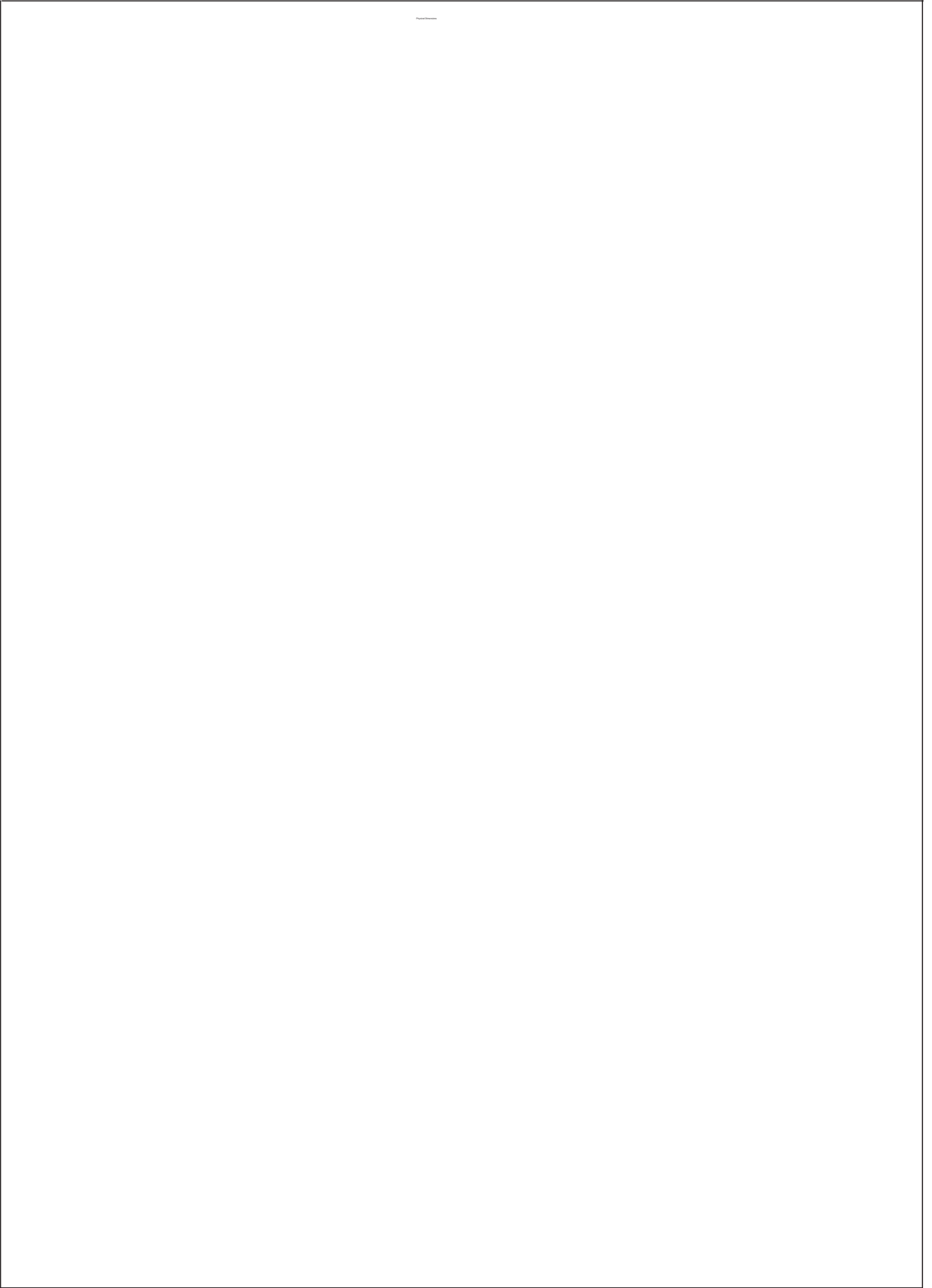

Physical Dimensions inches (millimeters) unless otherwise noted

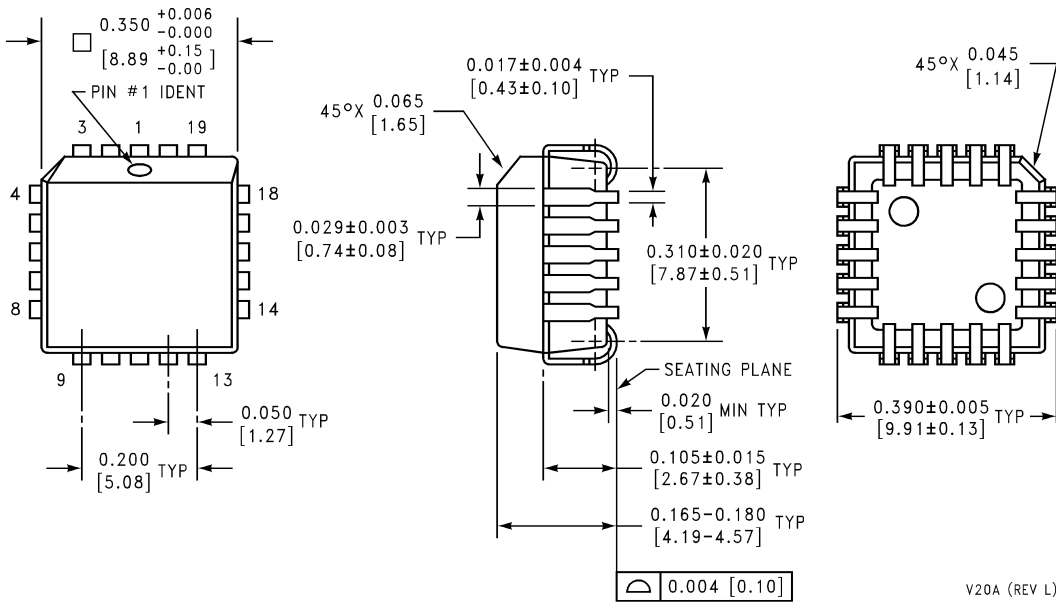

Plastic Chip Carrier Package
Order Number LM9044V
NS Package Number V20A

V20A (REV L)

LIFE SUPPORT POLICY

NATIONAL'S PRODUCTS ARE NOT AUTHORIZED FOR USE AS CRITICAL COMPONENTS IN LIFE SUPPORT DEVICES OR SYSTEMS WITHOUT THE EXPRESS WRITTEN APPROVAL OF THE PRESIDENT AND GENERAL COUNSEL OF NATIONAL SEMICONDUCTOR CORPORATION. As used herein:

1. Life support devices or systems are devices or systems which, (a) are intended for surgical implant into the body, or (b) support or sustain life, and whose failure to perform when properly used in accordance with instructions for use provided in the labeling, can be reasonably expected to result in a significant injury to the user.
2. A critical component is any component of a life support device or system whose failure to perform can be reasonably expected to cause the failure of the life support device or system, or to affect its safety or effectiveness.



National Semiconductor Corporation
Americas
Email: support@nsc.com

National Semiconductor Europe
Fax: +49 (0) 180-530 85 86
Email: europe.support@nsc.com
Deutsch Tel: +49 (0) 69 9508 6208
English Tel: +44 (0) 870 24 0 2171
Français Tel: +33 (0) 1 41 91 8790

National Semiconductor Asia Pacific Customer Response Group
Tel: 65-2544466
Fax: 65-2504466
Email: ap.support@nsc.com

National Semiconductor Japan Ltd.
Tel: 81-3-5639-7560
Fax: 81-3-5639-7507

www.national.com